

入力轴  
Input shaft

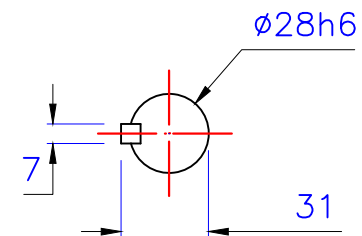

出力轴  
Output shaft

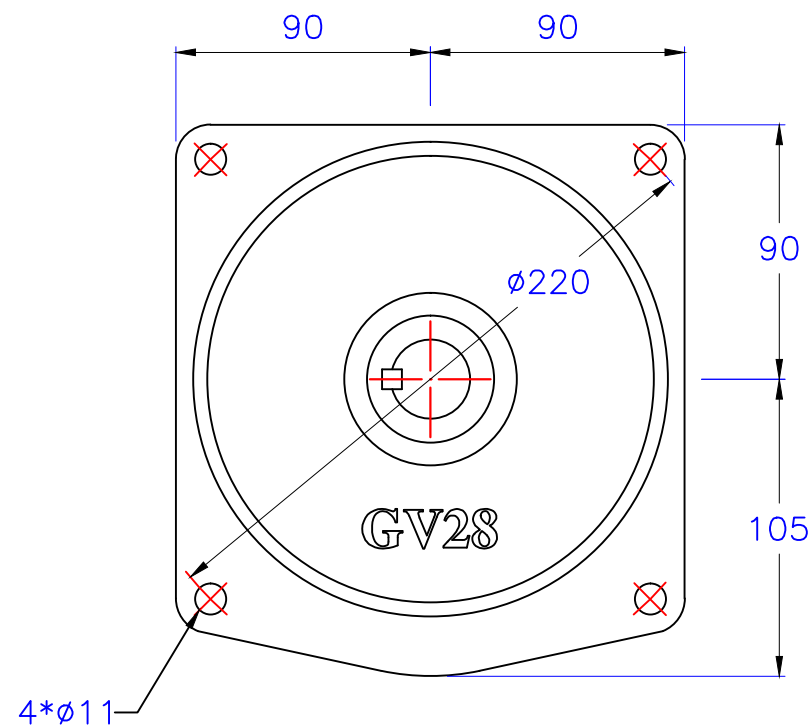
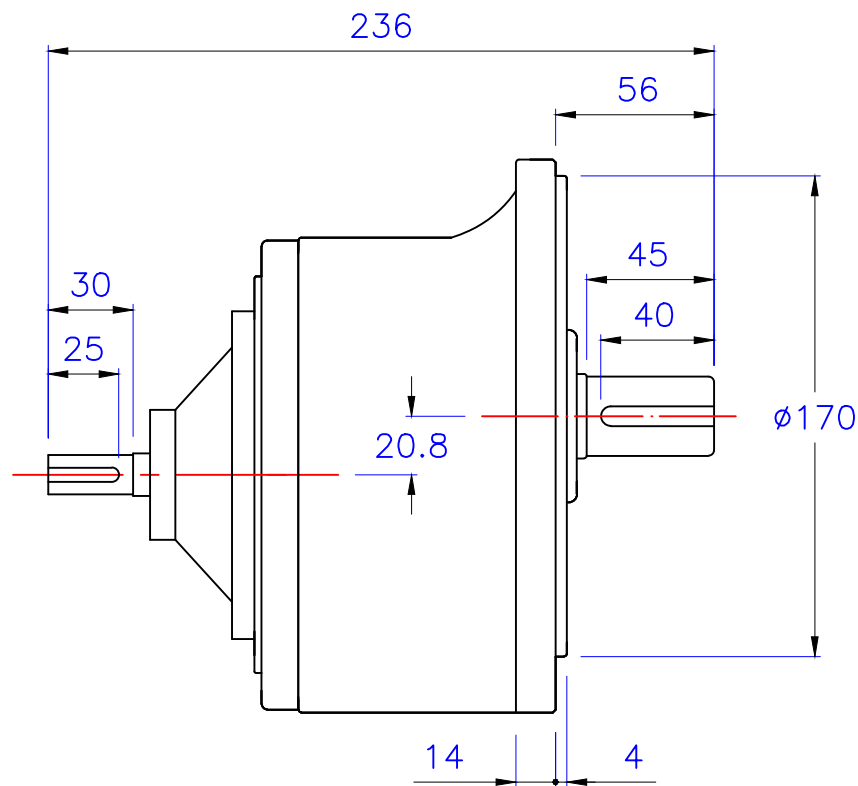

版权所有

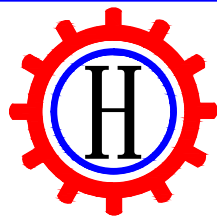

東莞豪鑫機電有限公司  
DONG GUAN HOU SIN CO.,LTD.  
Tel:86-769-81568855  
Fax:86-769-81568858  
Http://www.housinmotor.com

### 1/2HP立式双轴型齒輪減速机

圖號	GVD28-400-15~90	繪圖	肖飞平
版本	第三版	審核	
修訂日期	2015-5-9	比例	1:1